

Accessory: Blanking Plate, used with Waveguide interface, omt's, couplers

**104475-28WR**

## SPECIFICATIONS

### General

Item	Accessory: Blanking Plate
Used With	Waveguide interface, omt's, couplers

\*Additional OEM interfaces and adapters may be available. Contact RadioWaves for a complete and current list of available adapters.

### Mechanical

Net Weight	consult factory	Operating Temperature Range	-40 to +60 C
Mechanical Configuration	BPLATE		

### Regulatory Compliance

RoHS-compliant	Yes
----------------	-----

### Shipping Information

Package Type	consult factory	Dimensions, L x W x H	consult factory
Gross Weight	consult factory	Shipping Volume	consult factory

TECHNICAL DRAWINGS

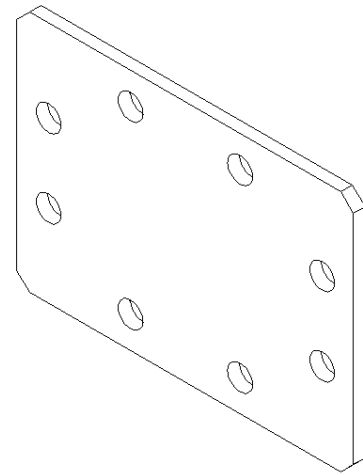
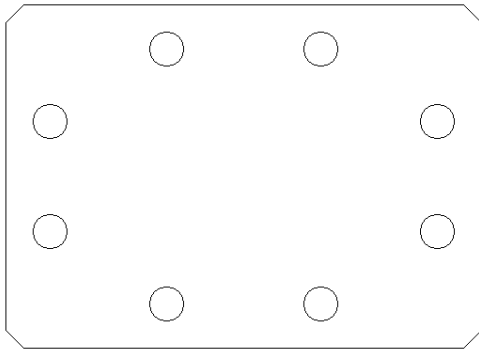

**OL-BPlate**